

Data sheet

Commercial Art.No.: 0D.S11.3327.0

insert bridge IVB WTN 10-3 IN

insert bridge IVB WTN 10-3 IN modular spacing 10 mm, insulated yes, number of poles 3, color grey, height 26.7 mm, mounting methodscrewable, inflammability class of insulation material acc. with ul94 V0

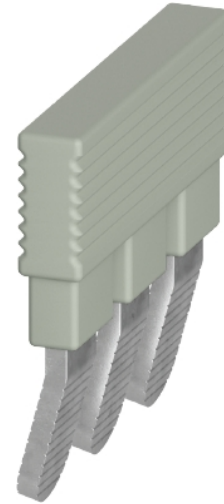

Commercial Art.No.	0D.S11.3327.0
EAN	4049088723674
Order Unit	100

Technical data

general

color	grey
inflammability class of insulation material acc. with UL94	V0
width/grid dimension	28.4 mm
length	4.5 mm
modular spacing	10 mm
number of bridged clamps	3
mounting method	screwable
insulated	yes
model	cross connector
height	26.7 mm

classification

ETIM 9.0	EC000489
----------	----------

product compliance

REACH-SVHC conformity status	compliant
------------------------------	-----------

A
 © Alle Rechte vorbehalten
 © All rights reserved
 Vertraulich
 Confidential

B
 These dimensions will be especially checked at delivery
 Only inspection dimensions
 With /E marked dimensions are only valid for internal use

C
 Diese Maße werden bei Abnahme besonders geprüft
 Ausschließlich Prüfmaße
 Mit /E gekennzeichnete Maße sind nur für interne Zwecke gültig

F
 2025-11-19 10:24:45 1.000

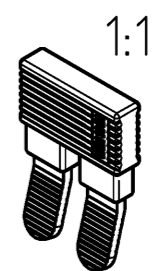
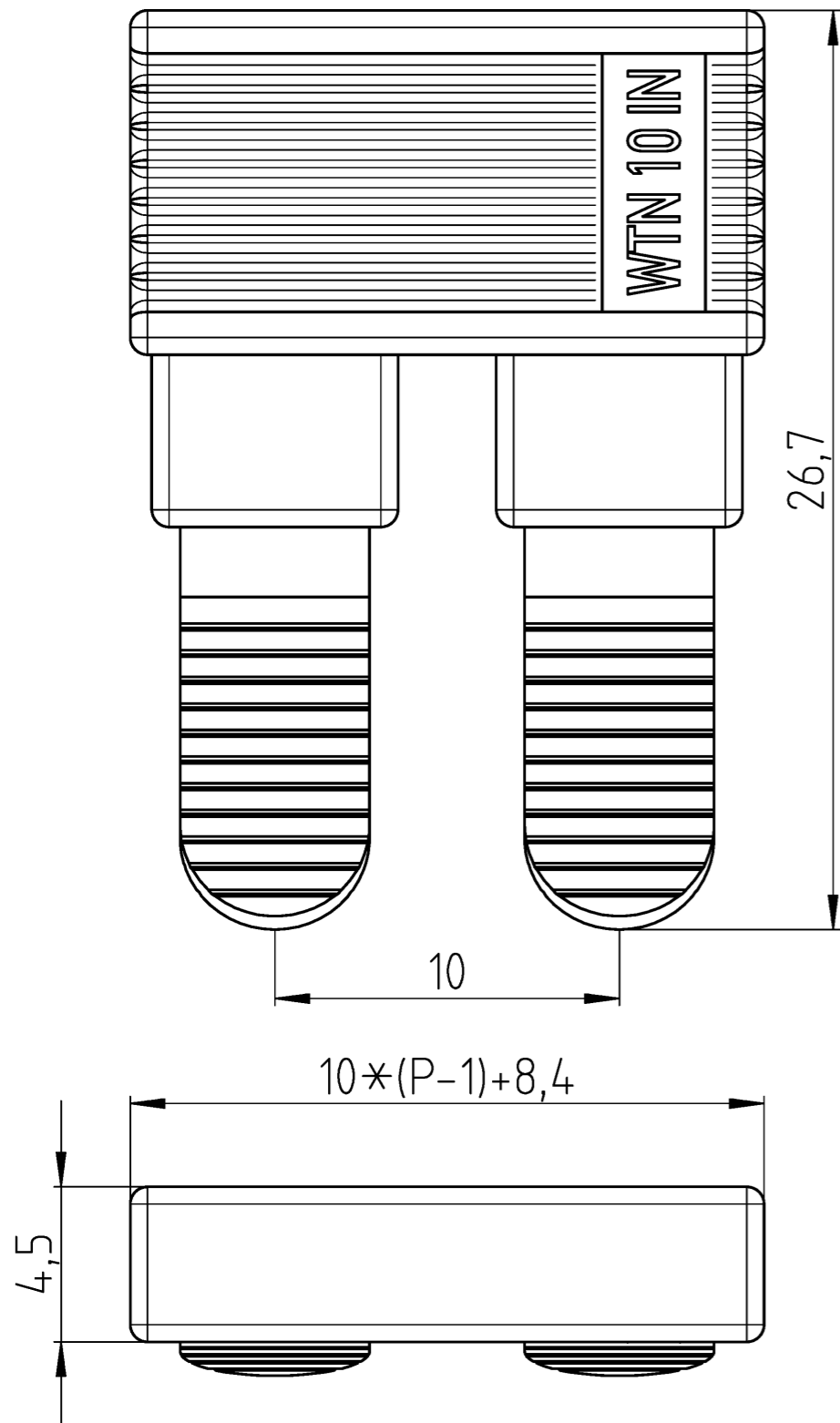

Weitere Daten siehe KATALOG oder eKatalog
 additional data see CATALOG or eCATALOG
www.wieland-electric.com
eshop.wieland-electric.com

Tolerierung Size ISO 14405 ☺ / Tolerance system Size ISO 14405 ☺. (This ISO-standard describes the envelope principle. According to the envelope principle the deviations of form and parallelism are limited by the size tolerances).		ja/yes <input checked="" type="checkbox"/> Stoffverbots- und Deklarationsliste nach WN 5020.010 ist einzuhalten. Conformity with Wieland document WN 5020.010 e (list of prohibited / declarable hazardous substances) to be declared!	
Freitoleranz nach General tolerance		CAD - Zeichnung, keine manuellen Änderungen CAD - drawing, no manual modifications allowed	
1. Verwendung: First Use:		Blatt: 1 von 1 Sheet: 1 of 1	
Werkstoff / Material		Tag/Date Name	
Maßstab / Scale		gezeichnet drawn 30.09.2025 Eichhorn N.	
5:1		Elektronische Freigabe Electronic Release	
Vol. mm ³ / Of./Srf. mm ²		Ersatz für / Replacement for:	
a 19.11.2025 / Index Datum / Blatt Date / Sheet		Type Benennung/Title	
Änderung / Revision		wieland	
		T 0D.S11.3227.0 13K a Maße in mm / Dimensions are in mm	
		EINLEGEBRUECKE connection plug	